

# Bring on more acres.

The all-new LEXION 8000-7000.



# The new LEXION.

Brighter thinking means a brighter business for you.

Our passion for building combines dates back to 1936, and since then we have continuously shaped the history of harvesting technology. Indeed, no other company has played such a significant role as CLAAS in the development and innovation of today's combine harvesters. But there is more to what we do than advancing technology – we understand the needs of our customers. Much of what farmers and contractors tell us drives our development process to ensure our products fit the needs of their businesses. The demands of our changing world are also constantly driving us forward.

These drivers have made us what we are today: the business-minded manufacturer for the business-minded ag professional. And the partner of choice for revolutionary harvesting technology. We put our brightest thinking into cutting-edge products that help our customers save more time and make more money. So their businesses are even better than before.

This means the new LEXION combine is much more than the latest model in the series. It is a combine that has been redesigned and redeveloped from the ground up in close cooperation with those who will use it as a tool to get more from each day and create their own success. Together, we have combined brighter ideas for our mutual benefit. These ideas not only come from our exacting nature and always wanting to improve - they are also the result of our sheer enthusiasm and passion for agriculture. Because we know that, together, this results in an even brighter future for us all.



Cathrina Claas-Mühlhäuser  
Chair of the Supervisory Board

How do we innovate at CLAAS?

It's simple. By working continuously to make harvesting technology better, faster and more efficient. And, a little different, too.



# Turning heads and acres in record time.

The CLAAS LEXION combine is an engineered mix of efficiency, precision and convenience – all in a reliable and easily-maintained package. Everything is designed with your efficiency in mind. Because we know that you can't put more hours in the day, but you can put in more acres.

We also know a LEXION combine isn't for everyone. It's for those with a plan. For those who want to take more control of their operation and do things the smartest way - not necessarily the way they've always been done. A LEXION combine is for leaders. Is it for you?

up to **610** hp

up to **510** bu  
grain tank

up to **5.1** bu/sec  
unload speed

up to **25** mph  
transport speed

# **1**  
in in-cab convenience  
features

# **1**  
in throughput capacity  
per class size





30 in

1

Threshing cylinder size increased by 26% to further improve crop flow and grain quality.

A machine that's as  
ambitious as you are.

### APS SYNFLOW HYBRID.

Like you, we don't spend a lot of time thinking about what everyone else is doing, because we know the status quo is often what holds you back. Brighter ideas always start by bringing fundamental change to the established way of doing things. In the case of the LEXION 8000-7000 combine, there are multiple advancements on board, including the new APS SYNFLOW HYBRID technology. Replacing the APS HYBRID SYSTEM that was developed by CLAAS in 1995, the APS SYNFLOW HYBRID system was designed from the ground up to raise the bar on combine productivity. The highest capacity processor on the market just got even bigger, and the combination of the APS SYNFLOW threshing system and ROTO PLUS separation system makes the APS SYNFLOW HYBRID system the throughput leader in every class. All this allows the LEXION combine to create unmatched efficiency without compromising the quality of your harvest.

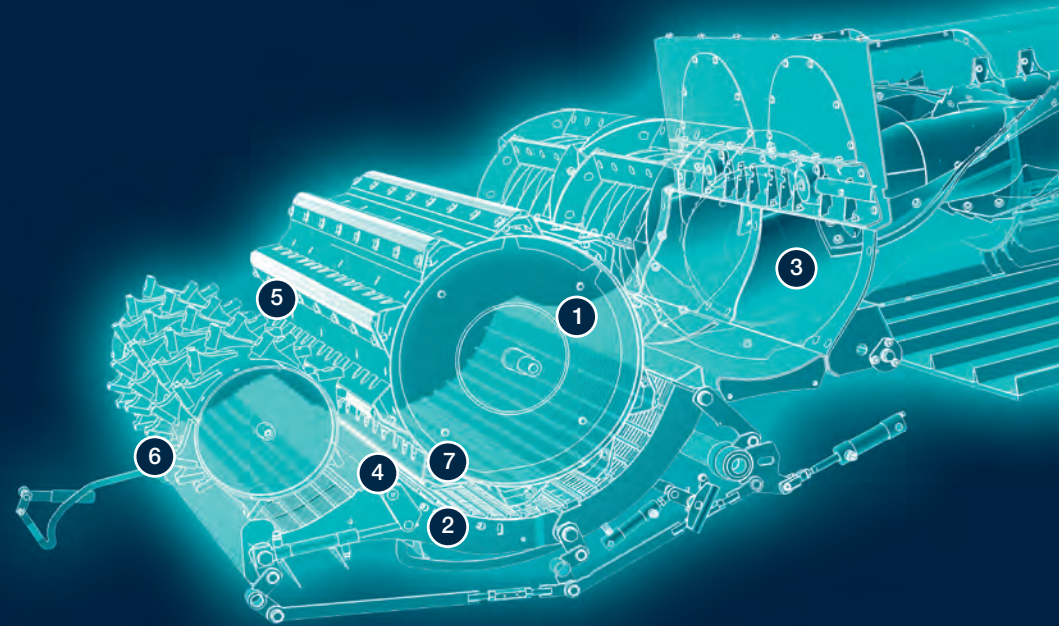

Hydraulic concave  
blanking plate

2

Can be engaged from the cab to intensify threshing action.



## More capacity

Enhanced rotor grates and additional cover plates increase rotor capacity and versatility.



8

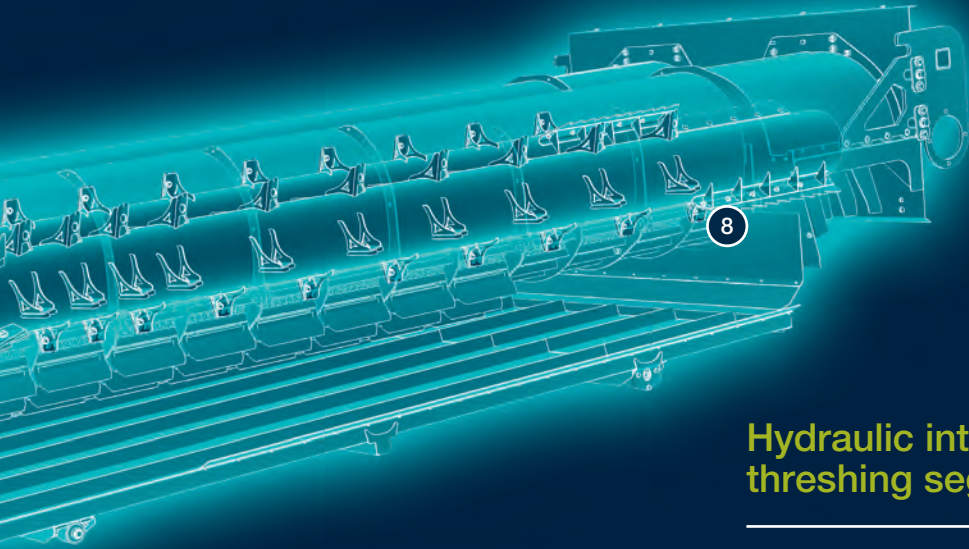

## Hydraulic intensive threshing segment

Can be engaged from the cab to intensify threshing action.



4

# 24 in

3

Feed impeller size enlarged by 37% to further improve crop flow and grain quality.

## MULTICROP

7



Complete crop conversion can take place from the cab.

## High-performance pre-separation

Pre-separate up to 30% of the crop before it reaches the threshing area.



6

## Crop Flow

5



One-to-one feed-to-thresh ratio paired with a straight line crop flow results in fuel efficiency, gentle crop handling, and maximum capacity.

## Convenience

Save time and money with minimal downtime between crops thanks to in-cab crop conversion capabilities and the fastest road speed on the market.

### MAX TRANSPORT SPEED

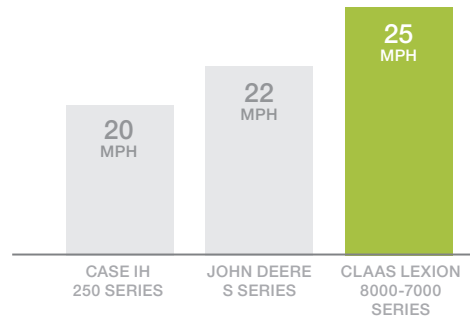

### CROP CONVERSION CAPABILITIES

	CASE IH 250 SERIES	JOHN DEERE S SERIES	CLAAS LEXION 8000-7000 SERIES
Threshing Speed	N / A	Manual	Push-Button
Chopper Speed	Manual	Manual	Push-Button
Residue Size Control	Manual	Manual	Push-Button

Decrease daily maintenance time due to the central lubrication system and DYNAMIC COOLING.

### MAINTENANCE TIME

	CASE IH 250 SERIES	JOHN DEERE S SERIES	CLAAS LEXION 8000-7000 SERIES
Grease Zerks Within System	N / A	N / A	Up to 74
Grease Zerks Under 10 Hours	0	Up to 8	0
Daily Greasing Time (min)	0	15	0
Daily Air-filter maintenance (min)	15	15	0
Daily Machine Clean Off Time (min)	42	45	20
<b>Daily Maintenance Time (min)</b>	<b>60</b>	<b>75</b>	<b>20</b>

## Efficiency

Harvest more acres per hour than any other combine on the market thanks to the capacity of the APS SYNFLOW HYBRID system.

### AVERAGE ACRES PER HOUR

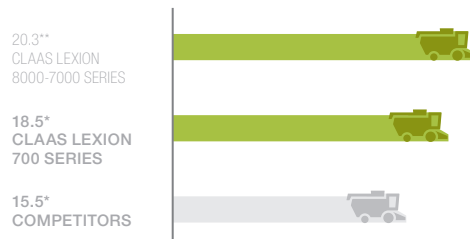

Save money on fuel due to efficient machine design and DYNAMIC POWER.

### FUEL USAGE

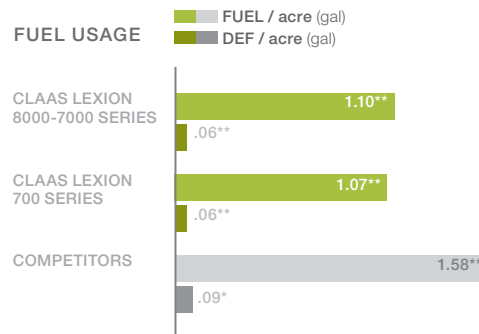

A grain handling system that features the industry's largest grain tank and a faster unload speed, matched perfectly with the highest capacity processor per class size in the industry, means less unloads needed.

### CAPACITY AND UNLOAD SPEEDS

	CASE IH 250 SERIES	JOHN DEERE S SERIES	CLAAS LEXION 8000 SERIES	CLAAS LEXION 8000 SERIES
Max Unloading Rate (bu/sec)	4.50	3.8	3.8	5.1
Max Grain Tank Capacity (bu)	410	400	385	510
% More Unloads Needed	31	26	21	—

\* Derived from Value Calculator data based on class 9 combines. \*\* Derived from internal studies and estimates.



## Precision

CEMOS AUTOMATIC autonomously and automatically makes real-time, in-field adjustments with more precision and speed than a seasoned operator, which results in: Individual

### CEMOS BY THE NUMBERS

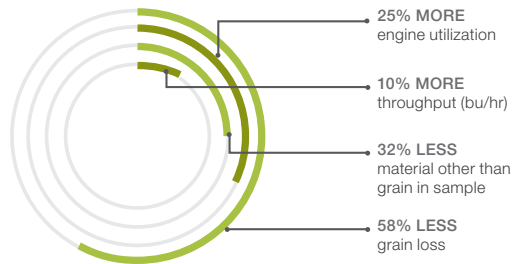

threshing and separation speed adjustment capabilities allow the operator to set the machine precisely for the crop and condition it is harvesting in – meaning minimal grain loss.

### GRAIN LOSS COMPARISON



\* Derived from Value Calculator data based on class 9 combines.  
\*\* Derived from internal studies and estimates.

In-cab configuration adjustment capabilities give the operator complete control of machine configuration on-the-fly.

### CONFIGURATION TIME COMPARISON

	CASE IH 250 SERIES	JOHN DEERE S SERIES	CLAAS LEXION 8000-7000 SERIES
Grate Changeover	45	60	15
Rotor Blanking (min)	30	30	Push-Button
Threshing Enhancer (min)	30	30	Push-Button
Threshing Concave Blanking (min)	15	15	Push-Button

## Reliability

Expect minimal downtime with a reliable machine and reliable dealer service.

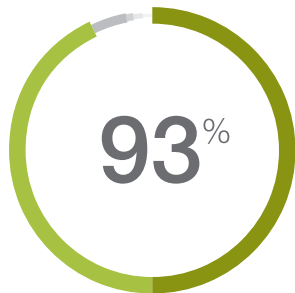

93% of CLAAS LEXION customers are satisfied / highly satisfied with dealer service.

96% parts fill rate from CLAAS Parts.

The **CLAAS On Your Farm Parts** program allows owners to customize a selection of parts to keep on their farm to prevent downtime.

Pick up CLAAS parts from one of the 225 combine or parts dealership locations.



# You find the land. We'll find the time.

The world's most productive combine continues to get even better. With the expanded capacity of the APS SYNFLOW HYBRID system, you'll get up to 10 percent more throughput. That, combined with the industry's largest grain tank and faster unloading speeds, creates a machine that's built to cut through acres. It's the only combine that can get more done in the same amount of time, without sacrificing the quality of what you get out of the field.

The LEXION combine is how you get out in front of your harvest season and stay there.



## APS SYNFLOW HYBRID.

- The enlarged threshing cylinder and feed impeller improve crop flow and grain quality
- 20% more threshing area
- Higher capacity rotor grates
- Achieve up to 10% more acres per hour

## DYNAMIC POWER.

- Optimizes power and fuel consumption to ensure there is power when needed and fuel efficiency when not
- Results in the lowest possible fuel consumption - up to 31% lower than nearest competitors - and reduces overall operating costs
- Provides a power boost when unloading on the go to ensure productivity is not compromised

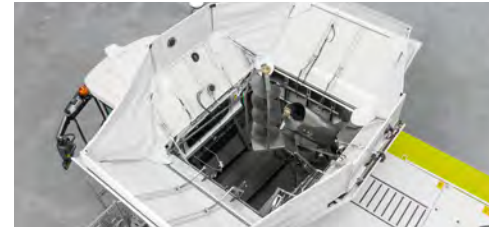

## Grain handling system.

- Each combine model is offered with the largest grain tank available per class, ranging from 510 bu to 385 bu
- The unload speed matches the grain tank capacity, reaching up to 5.1 bu/sec
- The grain handling system enables a LEXION combine with a 30 ft header harvesting a crop up to 250 bu/a to travel 0.5 miles before unloading





# Farming is a competition. This is how you win.

Everyone is looking for an edge, and the LEXION combine gives you the advantage you need. At the peak of precision is the CEMOS AUTOMATIC combine automation system that makes autonomous and automatic real-time in-field adjustments with more precision and speed than a seasoned operator. Equipped with more in-cab controls and on-the-fly adjustment capabilities, along with the highest-quality machine performance feedback, the LEXION combine makes certain you are always set up to succeed.



## CEMOS AUTOMATIC.

- Released in 2013, CEMOS AUTOMATIC is the industry's most experienced combine automation system
- Autonomously and automatically controls combine settings and adjustments
- Self-learning system tests alternative settings to ensure the machine is running at maximum efficiency
- Allows for full, automatic machine optimization



## Individual threshing and separation speed adjustment.

- The operator can more precisely adjust machine settings for changing crop conditions
- Superior operator control leads to less than one percent grain loss

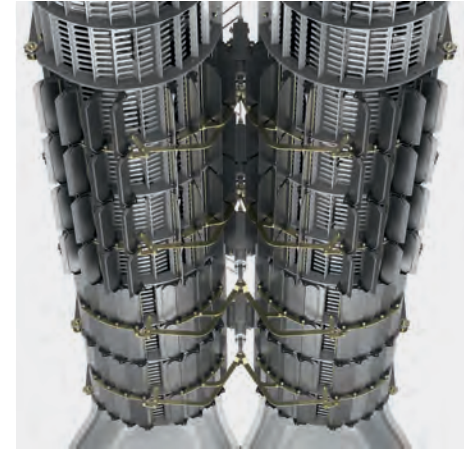

## Precise in-cab adjustments.

The LEXION combine features the most in-cab adjustment capabilities:

- Intensive threshing segment
- Concave blanking plate
- Rotor cover plates

# Built to save you time and make you money.

The LEXION combine is designed to save you time and make your job easier. Boasting the industry's fastest transport speed, this machine not only gets you through the field faster, but it also gets you to the next field faster. New in-cab conversion capabilities make it simpler and faster to switch between crops when needed. Daily maintenance time is shorted with features like the automatic central lubrication system, along with DYNAMIC COOLING. Your neighbors may not notice these creature comforts, but you certainly will.

## Transport speed.

The LEXION 8000-7000 series combines, from class 6 to class 10, TERRA TRAC or wheeled, have a top transport speed of 25 mph



## In-cab conveniences.

- In-cab dual range threshing speed adjustment allows the operator to switch from high to low speed range
- In-cab residue management speed adjustment allows the operator to switch from high to low speed range
- In-cab residue size control allows the operator to adjust particle size
- These exclusive in-cab adjustments reduce the time needed for crop conversion by more than 50%

## Maintenance features.

- The industry-exclusive DYNAMIC COOLING system pulls cool, clean air from above the machine through the radiator, into the engine compartment, and down the side panels
- The central lubrication system greases the machine while it is warm and moving, ensuring up to 74 grease zerks receive the correct amount of grease at the correct time
- When comparing the time required to perform daily routine maintenance, the LEXION combine requires less than 50% of the time required by competitors







# For those who know the window isn't getting any wider.

When it's time to run, your equipment and the support behind it need to be ready to go. We put the LEXION 8000-7000 combine through more durability testing than ever before. Our On Your Farm Parts stocking program and in-field service support are designed to maximize your uptime, and our parts centers boast some of the best fill rates in the industry. Our focus on harvesting provides understanding and pays dividends for you, and has resulted in a 93 percent customer satisfaction rating for us.

## On Your Farm Parts.

Have the parts you need, right where you need them. The CLAAS On Your Farm Parts program allows you to customize a selection of parts to keep on your farm in order to keep your machine running. CLAAS is committed to supporting your parts needs.



## North American parts centers

The CLAAS of America Parts Logistics Centers in Columbus, Indiana, and Regina, Saskatchewan, provide world-class parts throughout North America for all CLAAS products. They provide the CLAAS dealer network with reliable, consistent parts availability and industry-leading responsiveness. Whatever it takes.



Extensive testing for your farm's demands

Over **6,000** hours  
of durability testing

Over **8** years  
of testing in the field

In **10** countries  
in the most varied conditions and crop types

## Specifications

LEXION		8800/8800 TERRA TRAC	8700/8700 TERRA TRAC	8600/8600 TERRA TRAC	7500/7500 TERRA TRAC	7400/7400 TERRA TRAC
<b>Processor</b>						
APS SYNFLOW HYBRID		●	●	●	●	●
<b>APS SYNFLOW threshing system</b>						
Threshing drum width	in (mm)	67 (1700)	67 (1700)	67 (1700)	56 (1420)	56 (1420)
Threshing drum diameter	in (mm)	30 (755)	30 (755)	30 (755)	30 (755)	30 (755)
Feed impeller diameter	in (mm)	24 (600)	24 (600)	24 (600)	24 (600)	24 (600)
<b>ROTO PLUS separation system</b>						
Rotors	no.	2	2	2	2	2
Rotor length	ft (m)	13.75 (4.2)	13.75 (4.2)	13.75 (4.2)	13.75 (4.2)	13.75 (4.2)
Rotor diameter	in (mm)	17.5 (445)	17.5 (445)	17.5 (445)	17.5 (445)	17.5 (445)
Rotor grate area	degrees	150	150	150	120	120
Rotor grates	no.	6	5	5	5	5
Hydraulic rotor covers	no.	Up to 4	Up to 4	Up to 4	Up to 4	Up to 4
4D-cleaning system		○	○	○	○	○
<b>JET STREAM cleaning system</b>						
JET STREAM turbine fans	no.	8	8	8	6	6
3D-cleaning system		●	●	●	●	●
Side slope compensation	percent	Up to 20	Up to 20	Up to 20	Up to 20	Up to 20
<b>Grain tank</b>						
Capacity	bu (l)	510/425 (18000/15000)	510/425 (18000/15000)	510/425 (18000/15000)	385/355 (13500/12500)	385/355 (13500/12500)
Unloading rate	bu/s (l/s)	5.1 (180)	5.1 (180)	5.1 (180)	5.1 (180)	4.3 (150)
<b>Tier IV engine</b>						
Manufacturer / Type		Mercedes-Benz OM 473	MAN D26	MAN D26	Mercedes-Benz OM 470	Mercedes-Benz OM 470
Cylinders / displacement	no. / l	6 / 15.6	6 / 12.8	6 / 12.8	6 / 10.7	6 / 10.7
Rated power	hp (kW)	610 (455)	509 (380)	466 (348)	402 (300)	375 (280)
Max power	hp (kW)	653 (480)	549 (404)	507 (373)	462 (340)	408 (300)
DYNAMIC POWER		●	●	●	●	●
<b>Ground drive</b>						
25 mph (40 km/h)		●	●	●	●	●
Differential lock for wheeled machine		●	●	●	●	●
POWER TRAC		○	○	○	○	○
<b>Operator assistance systems</b>						
CEMOS CRUISE PILOT		○	○	○	○	○
CEMOS AUTOMATIC		○	○	○	○	○
CEMOS AUTO CROP FLOW		●	●	●	●	●
CEMOS AUTO SLOPE		○	○	○	○	○
CEMOS DIALOG		○	○	○	○	○
<b>Data management</b>						
TELEMATICS		●	●	●	●	●
Remote Service		●	●	●	●	●

# Thinking hard about growing your business? Think harder about a LEXION combine.

At CLAAS, being brighter means delivering on our promise to consistently provide solutions that improve our customers' businesses, as your success and our success go hand in hand.

We look forward to the opportunity to work with you.





CLAAS of America Inc.  
8401 South 132nd Street  
Omaha, NE 68138  
Phone +1 402 861-1000

**claas.com**

CL99881043 / 08/19

©2019 CLAAS of America Inc. All descriptions and specifications should be considered approximate and may include optional equipment. In certain cases, protective panels have been removed to show detail. To avoid risk of injury, never remove these panels yourself. Please refer to operators manual for instructions. Product and specifications subject to change without notice.